



NEX10®

COMPACT.
FLEXIBLE.
LOW-PIM.

RF Connectors and Jumper Cables
for Mobile Communications: NEX10®.

CONNECTORS FOR SMALL CELL APPLICATIONS

The NEX10® Series

Ever-increasing amounts of data have made further developments of global mobile networks essential. Above all, the development of 5G – the next generation of mobile communications – is creating new and more diverse tasks for the mobile communications industry.

The new NEX10® connector system* was developed to meet the existing and future demands of these upcoming small cell mobile networks. The NEX10® interface offers excellent PIM performance in a robust design and compact size.

*Produced under license

Electrical Parameters

Frequency Range	DC to 20 GHz
PIM (Passive Intermodulation)	≥ 166 dBc @ 2 × 43 dBm
Return loss (typ.)	≥ 36 dB @ DC to 4 GHz ≥ 34 dB @ 4 GHz – 6 GHz ≥ 30 dB @ 6 GHz – 10 GHz ≥ 20 dB @ 10 GHz – 20 GHz
Power handling	100 W (@ 2 GHz, 85 °C)
Mating cycles	≥ 100
Impedance	50 Ohm
Recommended torque / screw type	1.5 Nm
Degree of protection	IP68 (1 m, 24 hours)

The NEX10® interface is perfect for applications, such as small cells, distributed antenna systems (DAS) and MIMO antennas. With the optional push-pull and screw type locking mechanisms, this connector series is suitable for indoor and outdoor applications.



Universal Jack



Screw



Push-Pull



DIMENSIONS AND CABLE TYPES

Cable Types

Jack NEX10®



Plug NEX10®



Optimized for: Semiflex Cables



UT-85



UT-141



UT-250



1/4"



3/8"

*Produced under license

Compact RF Connector Series for Mobile Radios

- 5G ready
- Small Form Factor
- -166 dBc dynamic PIM stability
- Plug optimized for 1/4" and 3/8" Cables
- Frequency up to 20 GHz



Mechanical Dimensions

Screw Type Plug

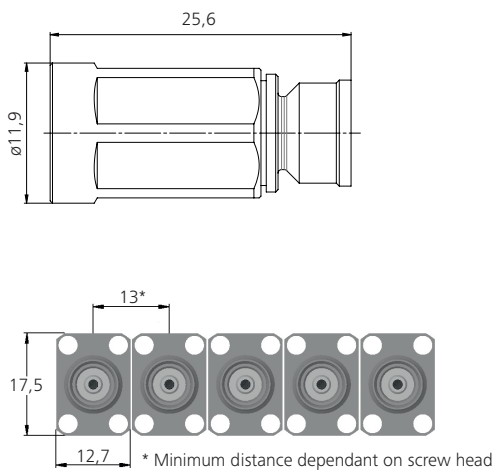

Push-Pull Type Plug

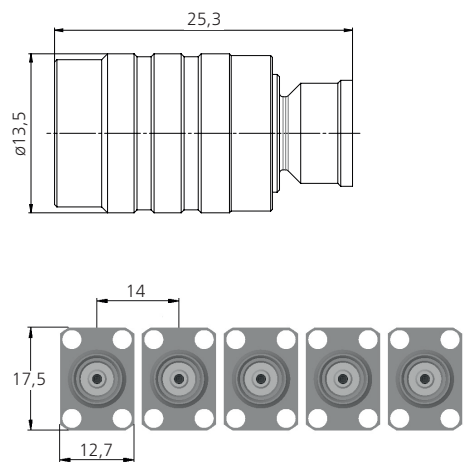

Universal Jack

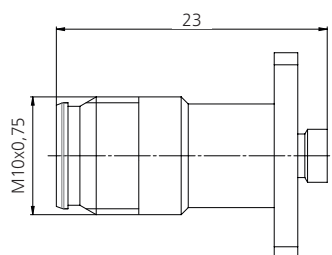



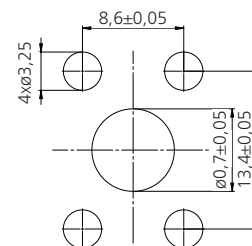









Mounting Dimensions



Order Information

NEX10® Straight Plug	Order no.	Cable group	Type	Remark/ Mounting dim.
	J01490A0000	G11 (UT-85)	Screw	
	J01490A3000	G11 (UT-85)	Push-Pull	
	J01490A0001	G10 (UT-141)	Screw	
	J01490A3001	G10 (UT-141)	Push-Pull	
NEX10® Angle Plug				
	J01490A0006	G10 (UT-141)	Screw	
	J01490A3006	G10 (UT-141)	Push-Pull	
NEX10® Straight Jack				
	J01491A0000	G11 (UT-85)		
	J01491A0001	G10 (UT-141)		
NEX10® Panel Jack				
	J01491A0003	G11 (UT-85)	12.7 x 17.5 mm	Z178
	J01491A0004	G10 (UT-141)	12.7 x 17.5 mm	Z178
	J01491A0010	G11 (UT-85)	20 x 20 mm	Z179
	J01491A0009	G10 (UT-141)	20 x 20 mm	Z179
NEX10® Bulkhead Jack				
	J01491A0006	G11 (UT-85)		Z04
	J01491A0007	G10 (UT-141)		Z04

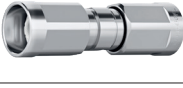
Order Information

Adapter 4.3-10 to NEX10®	Order no.	Description	Type	Remark/ Mounting dim.
	J01443A0017	f-m	Screw	
	J01443A0019	f-f		
	J01443A0020	m-f	Screw	
	J01443A0022	m-m	Screw - Screw	
Adapter NEX10® to 3.5				
	J01523A0005	m-f	Screw	
	J01523A0006	f-f		
	J01523A0007	f-m		
	J01523A0008	m-m	Screw	
NEX10® Adapter				
	J01492A0000	f-f		
	J01492A0001	f-f	Bulkhead	Z180
	J01492A0002	m-m	Screw - Screw	
	J01492A0003	m-f	Screw	

NEX10[®] JUMPER CABLES



Besides high-quality connectors for cables and devices, Telegärtner also offers factory-made jumper cables with the new NEX10[®] connector series*, following the highest quality standards.

Adding NEX10[®] jumpers to the portfolio makes Telegärtner the perfect partner for components in a wide range of mobile communications applications due to a full portfolio of all common mobile communication connectors. Telegärtner's convincing service enables customer-specific solutions as well as fast delivery times – even for small batch sizes.

*Produced under license

Order Information

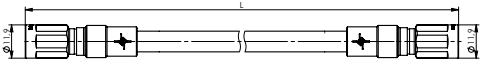
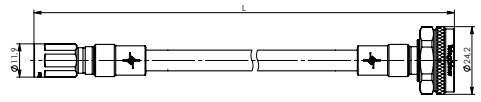
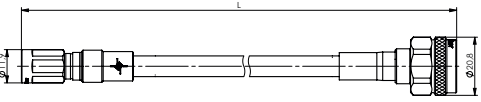
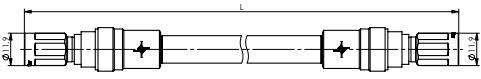
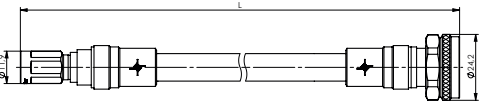
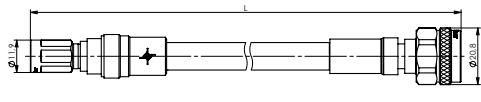
Superflexible 1/4" Jumper Cables	Order no.	Plug left side	Plug right side	Length
	L00010Q0214	NEX10® male Screw	NEX10® male Screw	1.0 m
	L00011Q0199	NEX10® male Screw	NEX10® male Screw	2.0 m
	L00012Q0187	NEX10® male Screw	NEX10® male Screw	3.0 m
	L00010Q0215	NEX10® male Screw	4.3-10 male Screw	1.0 m
	L00011Q0200	NEX10® male Screw	4.3-10 male Screw	2.0 m
	L00012Q0188	NEX10® male Screw	4.3-10 male Screw	3.0 m
	L00010Q0216	NEX10® male Screw	N male	1.0 m
	L00011Q0201	NEX10® male Screw	N male	2.0 m
	L00012Q0189	NEX10® male Screw	N male	3.0 m
Superflexible 3/8" Jumper Cables				
	L00012Q0190	NEX10® male Screw	NEX10® male Screw	3.0 m
	L00013Q0281	NEX10® male Screw	NEX10® male Screw	4.0 m
	L00013Q0284	NEX10® male Screw	NEX10® male Screw	5.0 m
	L00012Q0191	NEX10® male Screw	4.3-10 male Screw	3.0 m
	L00013Q0282	NEX10® male Screw	4.3-10 male Screw	4.0 m
	L00013Q0285	NEX10® male Screw	4.3-10 male Screw	5.0 m
	L00012Q0192	NEX10® male Screw	N male	3.0 m
	L00013Q0283	NEX10® male Screw	N male	4.0 m
	L00013Q0286	NEX10® male Screw	N male	5.0 m



Telegärtner
Karl Gärtner GmbH

Lerchenstr. 35
D-71144 Steinenbronn

Tel. +49 71 57/1 25-0
Fax +49 71 57/1 25-5120

info@telegaertner.com
www.telegaertner.com

Your distributor: